

a部詳細

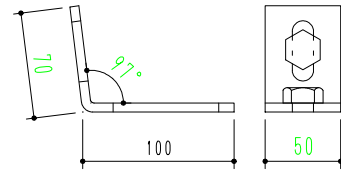

(FB-6t×50×170)

b部詳細

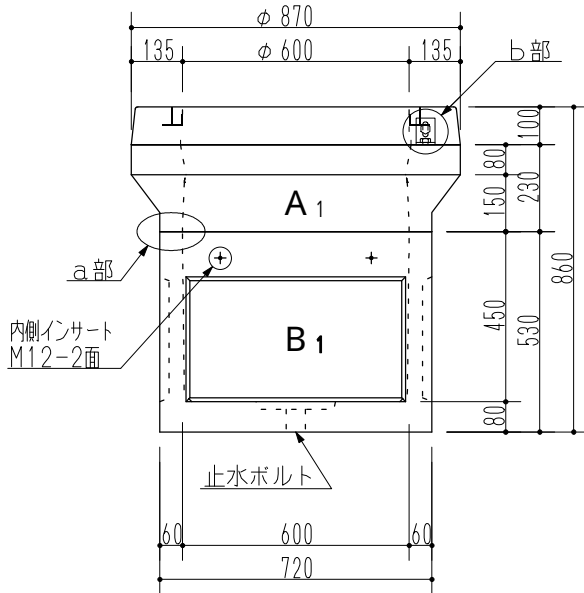
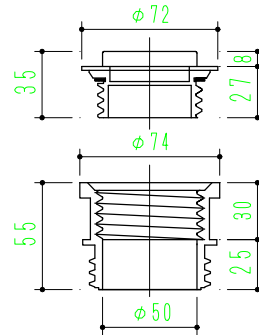

止水ボルト詳細

参考重量 544kg

品名承認	OK式ハンドホール(国土交通省H1-6型)				図面番号
	600×600×600H				
検図	設計	縮尺	1/20	0606	
フジプレコン株式会社					